

	A	B
STANDARD	1230	880
KOFFER L	1390	935
KOFFER XL	1490	1135

## SIDE

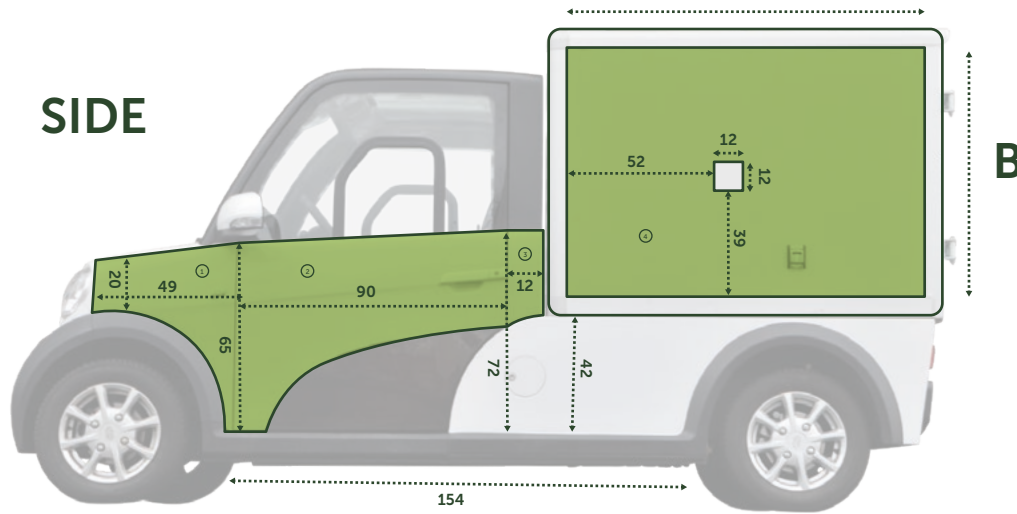

## HOOD

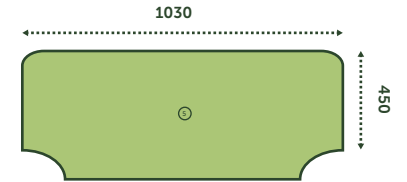

STANDARD 500  
KOFFER L 445  
KOFFER XL 470

STANDARD 500  
KOFFER L 425  
KOFFER XL 450



## BACK

STANDARD 850  
KOFFER L 875  
KOFFER XL 1075

# ARI 458 Koffer

All dimensions in mm



# SIDE

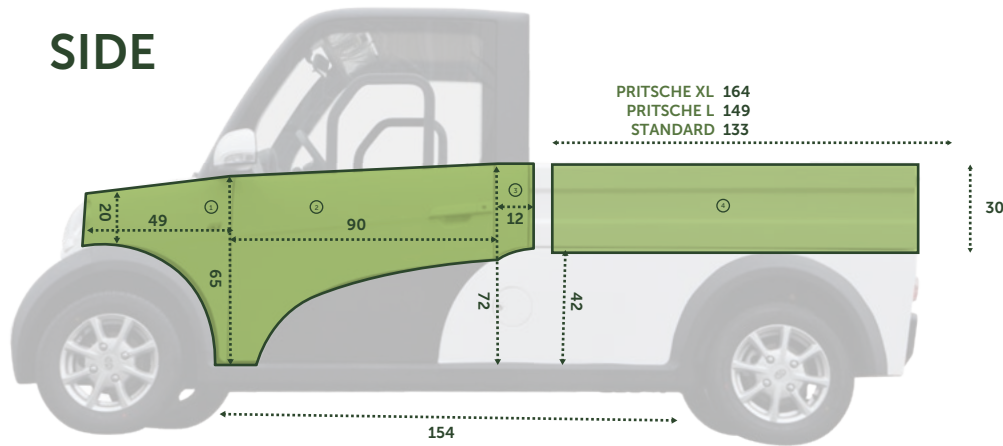

# HOOD

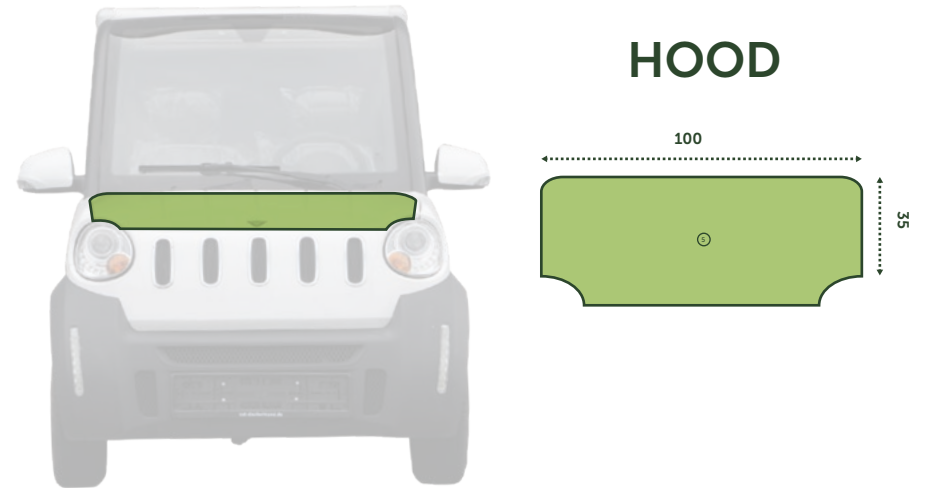

# SIDE

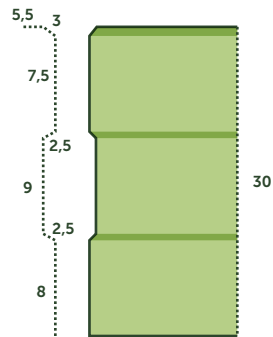

# BACK

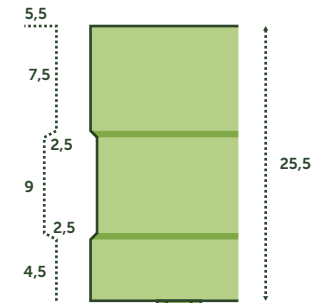

**ARI 458 Pritsche** (STANDARD, L & XL)



# SIDE

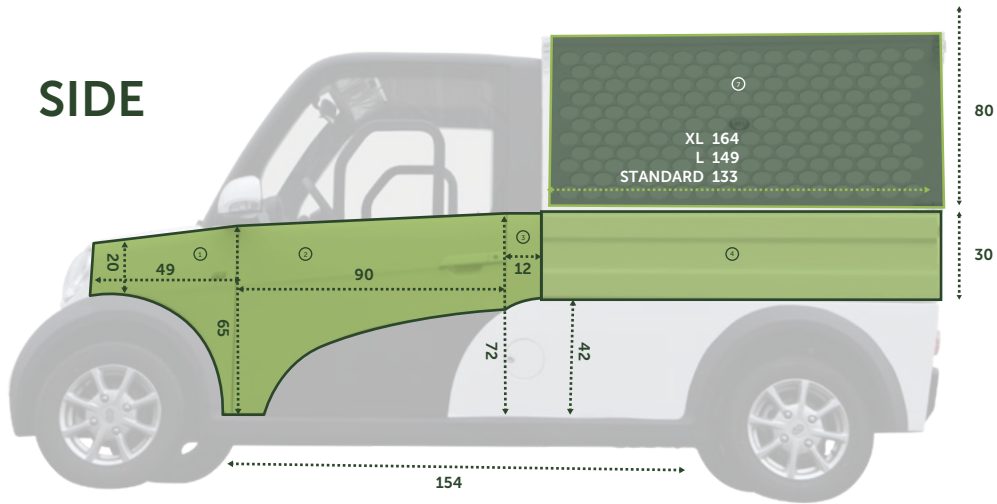

# HOOD

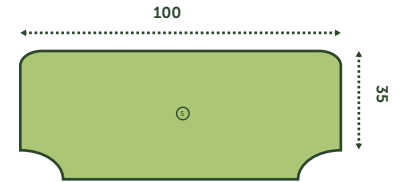

# SIDE

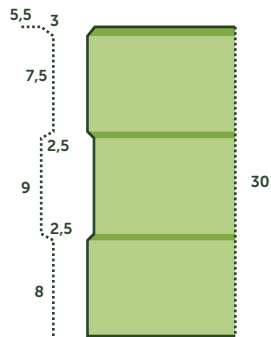

# BACK

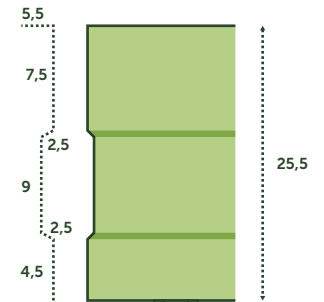

**ARI 458 Laubgitter** (STANDARD, L & XL)



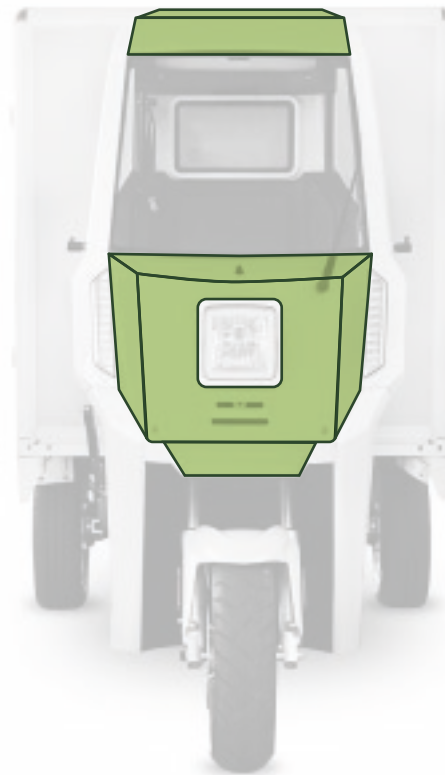
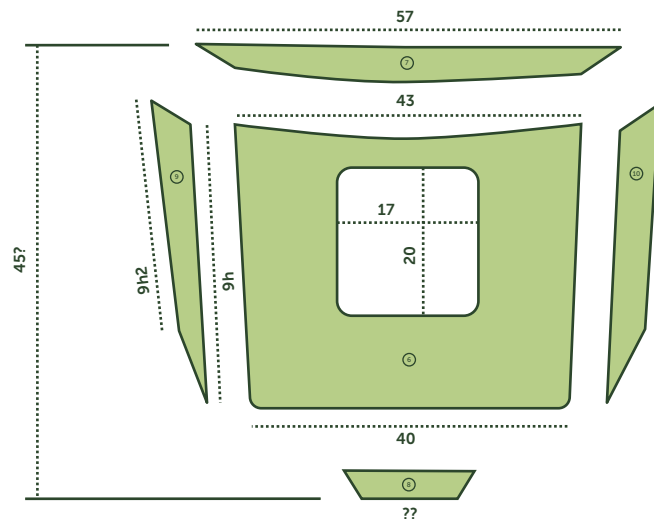
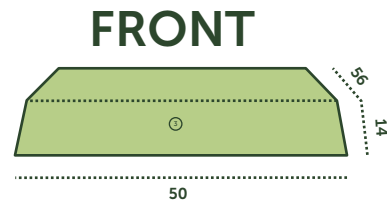
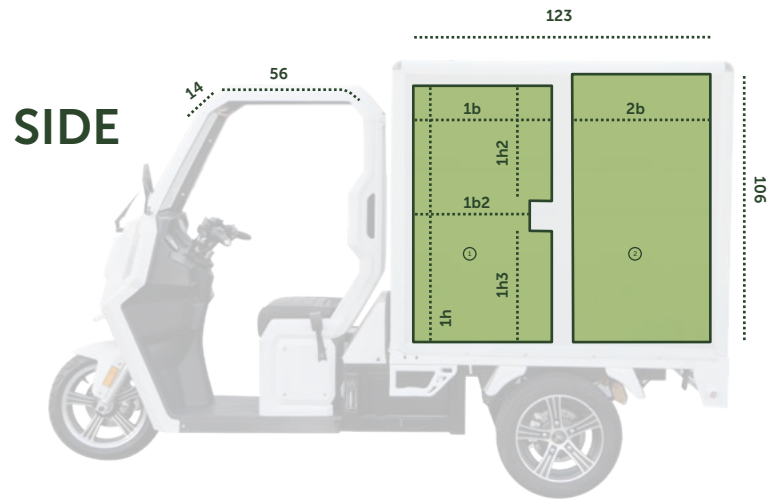

**ARI 345 Koffer**



**SIDE**

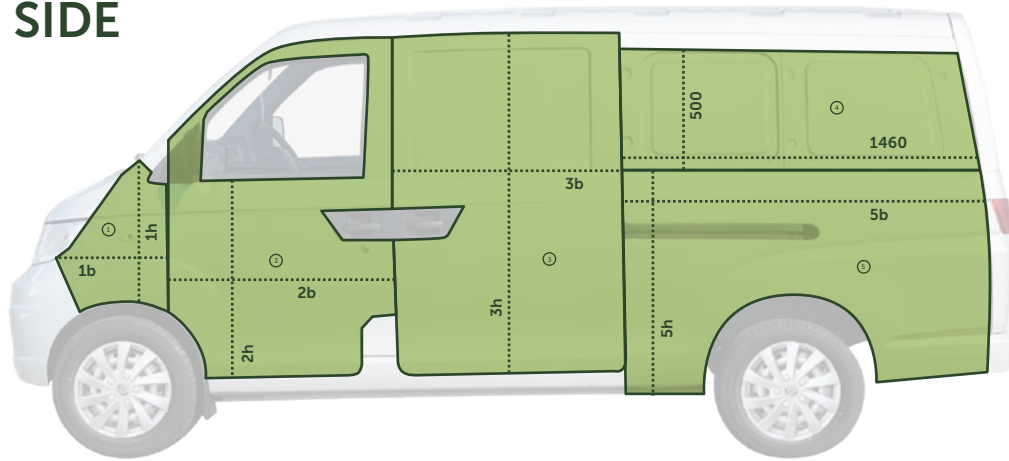

4430

**BACK**

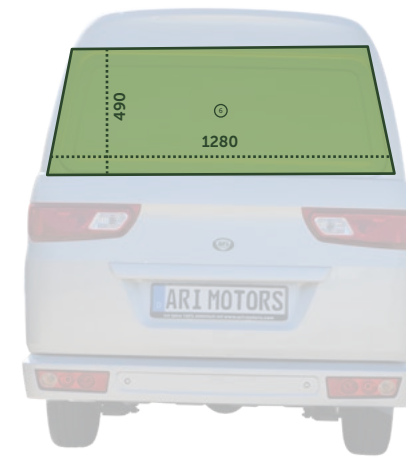

1626

1940

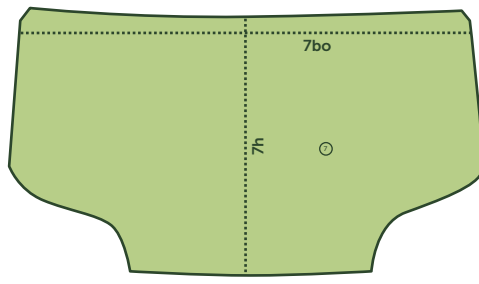

7bu



**FRONT**

**ARI 901 Kastenwagen**



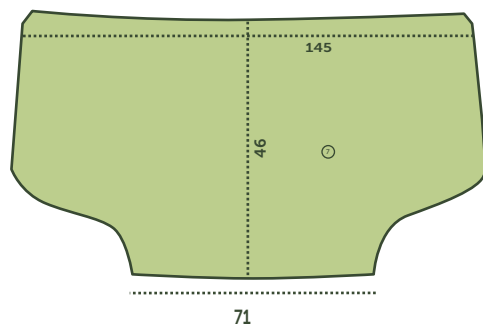
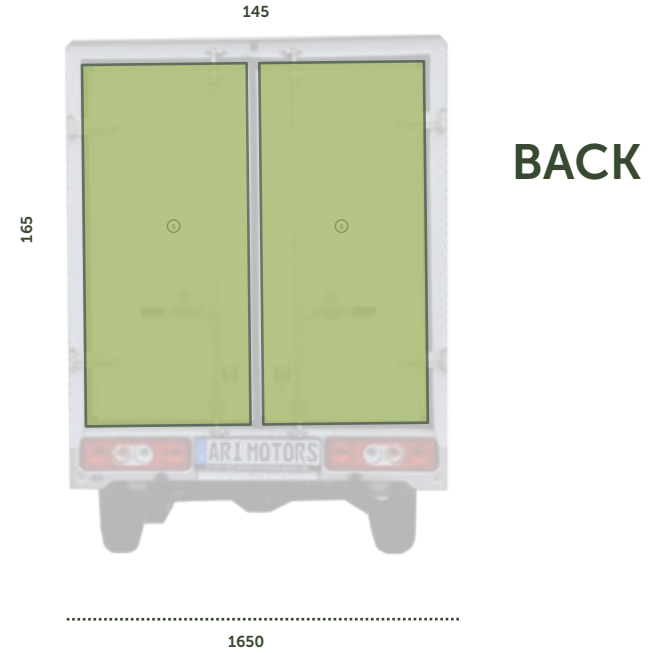
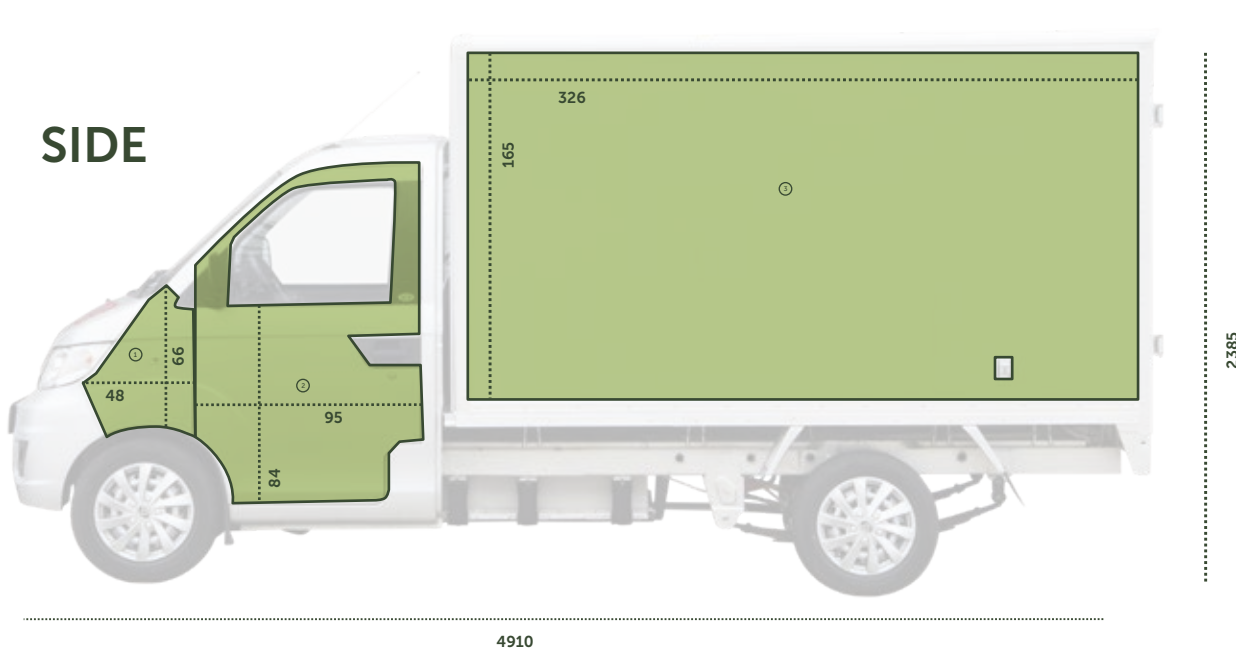

**FRONT**

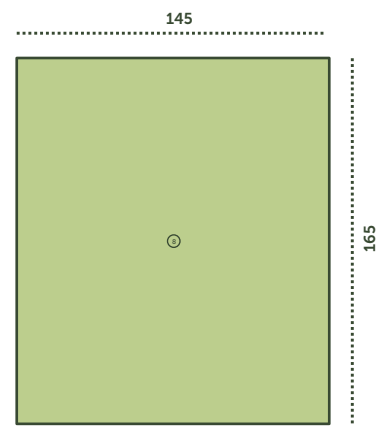
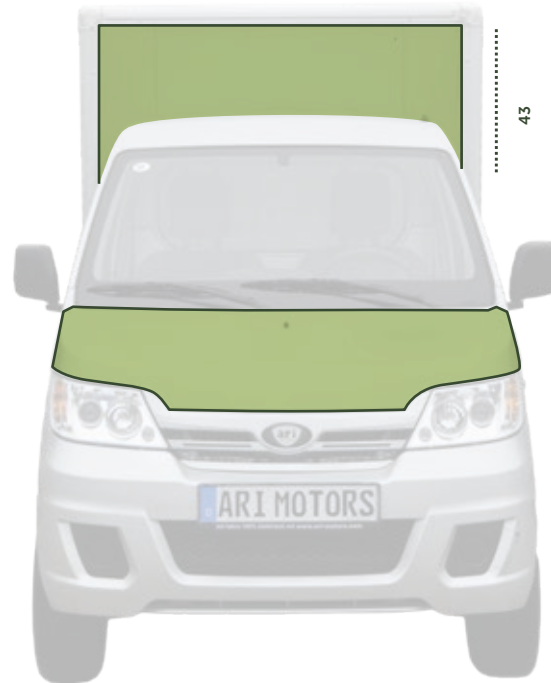

**BOX**

**ARI 901 Koffer**



FOOD TRUCK XL 1660

SIDE

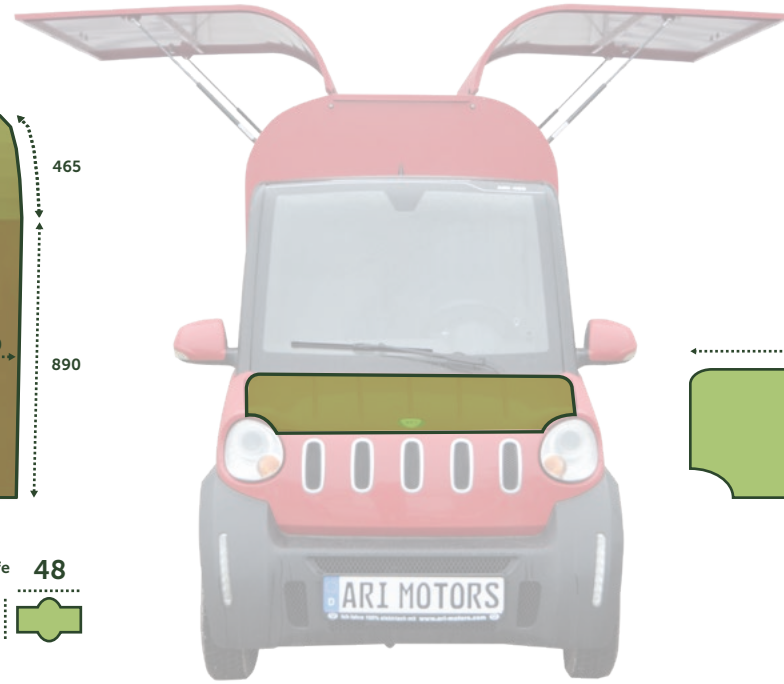
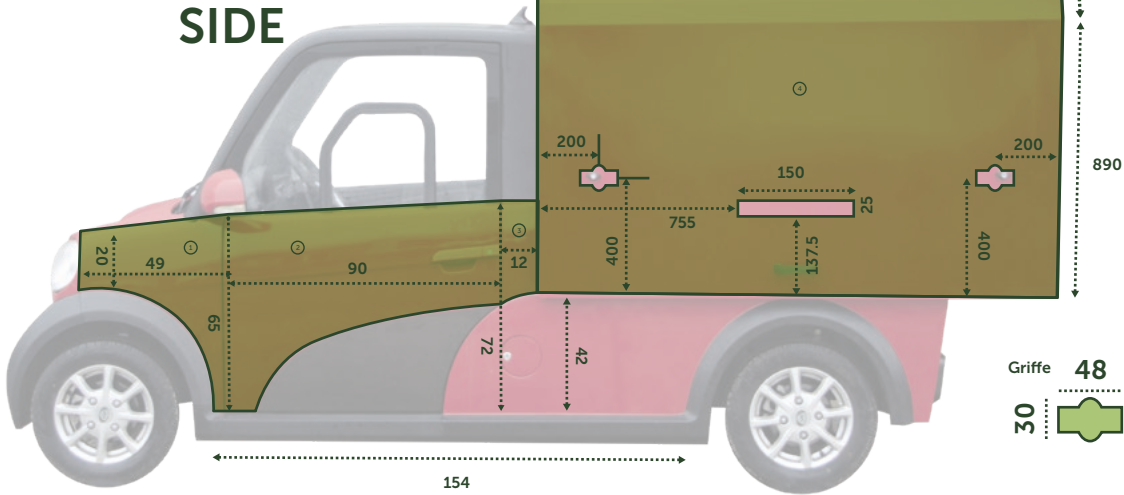

HOOD

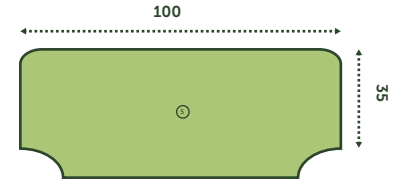

## ARI 458 Food Truck

### Beklebbare Flächen:

- ① Kotflügel
- ② Seitentür
- ③ B-Säule
- ④ Aufbau Seite
- ⑤ Motorhaube
- ⑥ Aufbau Rückseite
- ⑦ Aufbau Rückseite Klappe

BACK

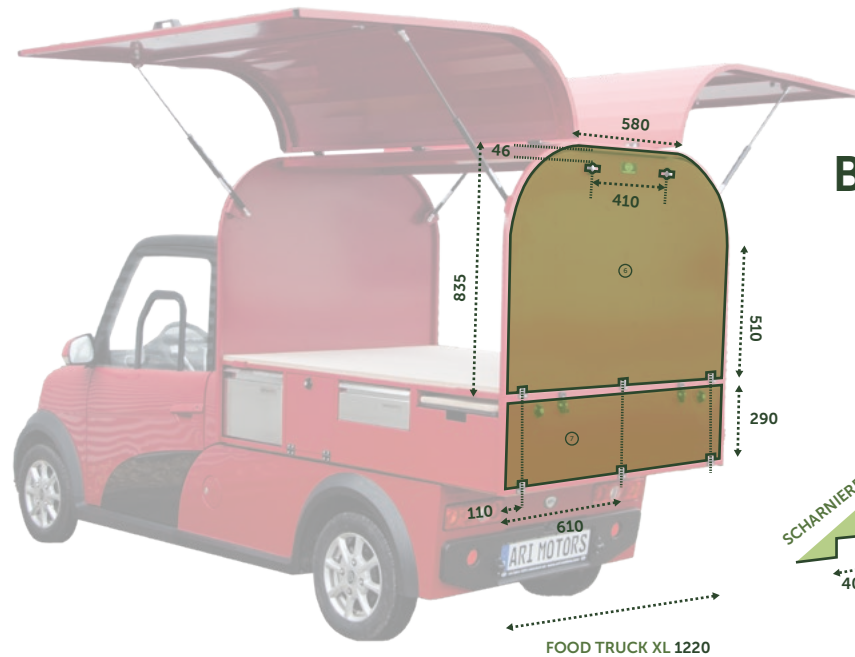

## SIDE

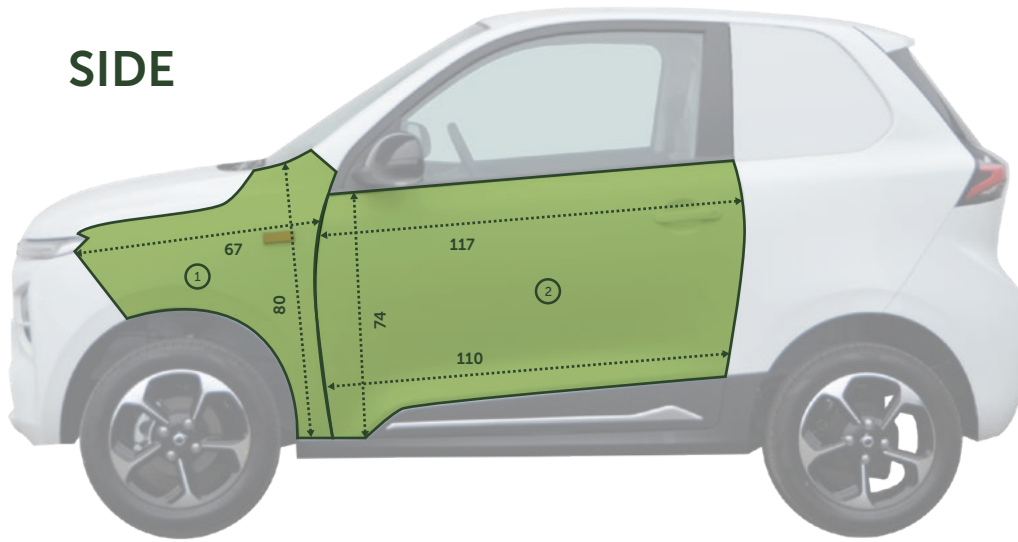

## HOOD

## ARI 902 Pure / Comfort / Cargo

### Beklebbare Flächen:

- ① Kotflügel
- ② Seitentür
- ③ B-Säule
- ④ Aufbau Seite
- ⑤ Motorhaube
- ⑥ Heckklappe
- ⑦ Dach

## BACK



## TOP

